

CF-2 Fraction Collector

D30195 • 230809

Spectrum Chromatography
P.O. Box 672026
Houston, TX 77267-2026

Toll-free (US & Canada) (800) 459-9700
Elsewhere (281) 443-2900
Fax (281) 443-3100
Email sales@lplc.com



The CF-2 Fraction Collector has been tested
and found to comply with:

IEC 801-2:1991
IEC 801-3:1988
IEC 801-4:1990
EN 55011, Group 1, Class A:1991
EN 50082:1992

Contents

Section Title	Page
1 Introduction	1
1.1 Description	1
1.2 Technical Specifications	1
2 Installation	4
2.1 Unpacking	4
2.2 Setup	4
2.3 Preliminary Checkout.....	5
2.4 Plumbing	5
2.5 Installing the Mast Package	6
2.6 Installing a Valve	7
2.7 Installing the Four Column Adapter ..	8
2.8 Connection to a Spectrum	9
Model 280 UV monitor	
2.9 Connection to a Spectrum Pump.....	9
2.10 Dust Cover	9
2.11 Case Top.....	10
2.12 Racks	10
2.13 Replacement Fittings	10
3 Operation Without the Peak	11
Separator	
3.1 Introduction	11
3.2 General Information	11
3.3 Fraction Collector Setup	11
3.4 Normal Operation.....	12
3.5 Stop Rack.....	13
4 Operation with the Peak Separator..	14
4.1 Introduction	14
4.2 General Information	14
4.3 Fraction Collector Setup	15
4.4 Normal Operation.....	15
4.5 Peak Detection.....	16
4.6 Time Windows	17
4.7 Fraction Size	17
4.8 Flow Delay	18
4.9 Program Save and Recall.....	19
4.10 Preview	19
4.11 Setup Changes	20
5 Help Messages	21
6 Theory of Operation	29
6.1 Circuit Descriptions	29
6.2 Power Supply	29
6.3 Microprocessor and Memory	29
6.4 Liquid Crystal Display	29
6.5 Analog Interface.....	30
6.6 Keyboard Interface.....	30
6.7 Drop Detector.....	30
6.8 Position Sensor.....	30
6.9 Output Control.....	30
6.10 Volume Conversion.....	30
7 Maintenance	35
7.1 Introduction	35

Section Title	Page
7.2 Case Top Removal	35
7.3 Cleaning Sensor Window.....	35
7.4 Sensor Assembly Replacement.....	35
7.5 Shuttle Cleaning.....	36
7.6 Shuttle Timing Procedure.....	36
7.7 Calibrating the Rack Sensor	37
7.8 Setting the Full-Scale Voltage.....	39
7.9 Replacing the EPROM	39
7.10 Voltage and Frequency Changes ...	39
7.11 Self-Test.....	40
7.12 Service Department	40
7.13 Shipping Returns.....	40
7.14 Replacement Parts.....	40
8 Programming Examples.....	42
8.1 Introduction.....	42
8.2 Example 1	42
8.3 Example 2	42
8.4 Example 3	42
8.5 Example 4	43
9 Ordering Information	44

Figures

Figure Title	Page
1-1 Front Panel Indicators	2
1-2 Rear Panel.....	3
2-1 Rack Sensor Position	4
2-2 Typical Startup Display.....	5
2-3 Assembling Flangeless Fittings.....	6
2-4a Side View of Mast Bracket	6
Installation	
2-4b Bottom View of Mast Bracket	7
Installation	
2-5 Four Column Adapter	9
3-1 Normal Display with Peak	12
Separator Off	
4-1 Normal Display with Peak	15
Separator On	
4-2 Programming Time Windows	17
4-3 Programming Fraction Size.....	18
4-4 Saving/Recalling Programs	19
4-5 Preview Selection.....	20
6-1 CF-2 Fraction Collector Block	29
Diagram	
6-2 Electrical Schematic	back
6-3 Remote Connector on Rear	32
Panel	
6-4 Pump or Drop Count	33
Connector on Rear Panel	
6-5 Pump Stop Connector on	33
Rear Panel	
6-6 Valve Connector on Rear	34
Panel	
7-1 Initial Shuttle Position	36
7-2 Far Tunnel Final Position	37
7-3 Near Tunnel Final Position	37
7-4 Circuit Board Layout.....	38
7-5 Voltage Jumpers Detail	39

Tables

Table Title	Page
1-1 Technical Specifications.....	1
1-2 Front Panel Indicators	2
1-3 Rear Panel Connectors.....	3
2-1 Cable Usage.....	10
2-2 Available Rack Sets	10
6-1 Volume Conversion	31
6-2 Remote Connector Pin	32
Assignments	
6-3 Pump or Drop Count	33
Connector Pin Assignments	
6-4 Pump Stop Connector Pin	33
Assignments	
6-5 Valve Connector Pin	34
Assignments	
7-1 Technical Troubleshooting	41
Chart	

1 INTRODUCTION

1.1 DESCRIPTION

The Spectra/Chrom[®] CF-2 Fraction Collector can be used with low-pressure liquid chromatography, RBLC, HPLC, and other procedures involving the measured collection of liquid fractions. Fractions can be collected on the basis of time (6 seconds to 999 minutes and 59 seconds); counted drops (1 to 9999 drops); or other counted events (1 to 9999), e.g., the volume pulses output by a Spectra/Chrom pump.

The maximum tube capacity is 174 tubes (12 or 13 mm diameter), 116 tubes (10 to 16 or 18 mm diameter), or 42 vials (28 mm diameter).

The Fraction Collector operates on 14 VAC supplied by a wall-mount transformer.

Special features of the CF-2 Fraction Collector include:

- Collection of fractions based on time, number of drops, or number of volumes.
- Automatic peak detection based on slope or threshold.
- Programmed delay time to allow for synchronization with the detector.
- Up to ten time windows may be programmed to control collection.
- Direct control of either a 2-Way Security Valve or a 3-Way Diverter Valve.
- On-line context-sensitive help messages guide the user through programming.
- Internal heaters allow operation in cold-rooms down to 0° C.

1.2 TECHNICAL SPECIFICATIONS

Table 1-1 details the technical specifications. Tables 1-2 and 1-3 in conjunction with Figure 1-1 and 1-2 explain the controls and connectors on the front and back of the Fraction Collector.

TABLE 1-1. TECHNICAL SPECIFICATIONS

Power Requirements	115±20 VAC, 20 VA 230±40 VAC, 20 VA	Event Mark Output	Open collector outputs, 1 for tube change, 1 for rack change
Line Frequency	45 to 65 Hz	Count Input	TTL low or contact closure for 1 ms to 1 s, or drop counter. Maximum count rate is 5 per second.
Dimensions	28 cm x 12 cm x 40 cm 11" x 4.5" x 16" w x h x l	Capacity	174 • 12 or 13 mm tubes 116 • 10 to 16 mm tubes 116 • 18 mm tubes or vials 42 • 28 mm tubes or vials
Weight	5 kg (10 lb)	Operating Temperature	0° to 40° C, noncondensing
Collection Basis	6 sec to 999 min and 59 sec in 1 sec increments, 1 drop or volume to 9999 drops or volumes in 1 drop or volume increments.		
Tube Change Time	0.35 sec maximum within 12/13 mm rack		

TABLE 1-2. FRONT PANEL INDICATORS

Item in Fig. 1-1	Description	Purpose
1	LCD Display	Display prompts and results
2	Power Indicator	Lit when the Fraction Collector is operating.
3	Valve Indicator	Lit when the optional 2-Way Security Valve is open or the optional 3-Way Diverter Valve is collecting.

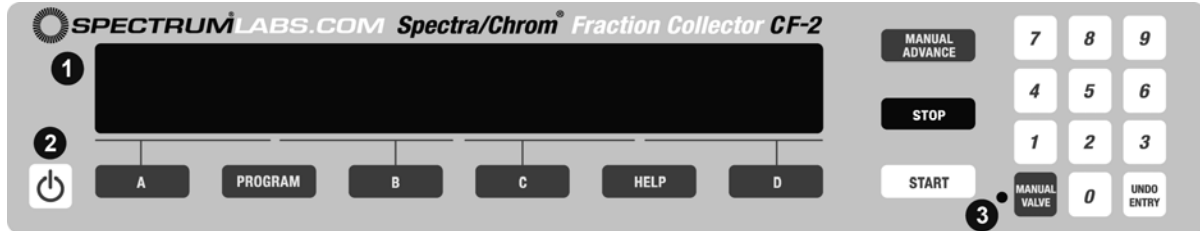

Figure 1-1. Front Panel Indicators

TABLE 1-3. REAR PANEL CONNECTORS

Item in Fig. 1-2	Name	Type	Function
1	Pump Stop	3 pin Jones	Used to shut off a pump at the end of a run.
2	Pump or Drop Count	6 pin Jones	Connection to drop counter or to pump when counting volumes. Also used to shut off pump between tubes.
3	Remote	15 pin Sub-D	Connection for remote control and event marking.
4	Connect to Ground	Thumbscrew	For grounding of the metal case of the Fraction Collector.
5	Power	5 pin DIN	14 VAC power input.
6	Valve	2 pin Jones	Connection to 2-Way Security Valve or 3-Way Diverter Valve.
7	Signal	Banana jacks	Signal input from detector for peak separator.



Figure 1-2. Rear Panel

2 INSTALLATION

2.1 UNPACKING

After removing the Fraction Collector and accessories from their shipping carton, examine them for signs of damage. If there is any shipping damage, file a claim with the delivering carrier immediately.

Check the contents of the shipment against the packing slip. If there are any discrepancies notify Spectrum immediately.

Save all packing materials and shipping cartons until you are sure that the instrument is working properly and all materials have been received.

2.2 SETUP

The Spectra/Chrom CF-2 Fraction Collector is normally shipped with a set of test tube racks installed. Since these may have been loosened during shipping, each rack should be pressed down firmly to secure it to its shuttle. If the automatic stop feature of the Fraction Collector is not to be used, the red rack should be replaced with the white rack shipped with the accessory package.

Mount the Rack Sensor and Mast Assembly (the assembly is permanently connected to the back of the Fraction Collector by a cable) on its mounting block at the center rear of the case top with the knurled thumbscrew provided. Do not remove the thin plastic film that protects the face of the sensor.

The proper position for the rack sensor assembly is shown in Figure 2-1.



Figure 2-1. Rack Sensor Position

Place the drop counter assembly on its mast. It should be placed high enough so that your test tubes will be able to pass beneath it. Plug the drop counter into the six-pin PUMP or DROP COUNT socket on the back panel. A final adjustment of the drop counter will need to be made later, prior to collecting fractions.

The Fraction Collector is powered by 14 VAC from a wall-mount transformer. Check the transformer supplied to be sure it is correct for your power mains. Damage to the instrument may result from connection to an inappropriate mains voltage. Connect the power cord to the POWER jack on the rear of the Fraction Collector.

2.3 PRELIMINARY CHECKOUT

After you have completed the setup described above and before you plumb the Fraction Collector, plug the AC adapter into the mains. This should cause the Fraction Collector to advance immediately to the next tube location, the display to briefly show a copyright message, and the indicator next to

the power button to light up. If this does not happen, press the  key on the front panel with power connected to the unit. If you are unable to get any response from the Fraction Collector, consult Table 7-1 for assistance or call Spectrum at (800) 459-9700 or (281) 443-2900.

If the Fraction Collector does not stop at the next tube location refer to Section 7 for help troubleshooting this problem.

After the copyright message is displayed, the Fraction Collector display should appear similar to that illustrated in Figure 2-2. Press the  key to turn the Fraction Collector off.

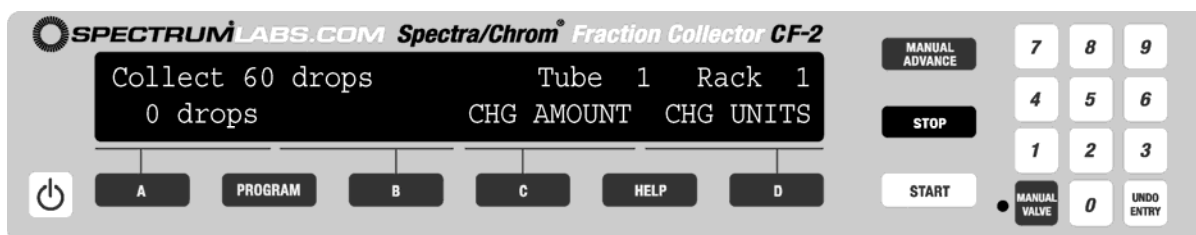

Figure 2-2. Typical Start-Up Display

If you will be installing any options, see the appropriate sections below. Once all of the purchased options are installed, proceed to either Section 3 (to use the Fraction Collector without activating its peak separator) or Section 4 (to use the Fraction Collector with its internal peak separator).

2.4 PLUMBING

The Fraction Collector will normally be plumbed as the final element in a chromatography system, connected to the outlet of the final detector used.

The Fraction Collector is shipped with both a hose barb connector and a set of flangeless nuts and ferrules to accommodate size 8, 12 and 14 Spectra/Chrom tubing. The flangeless fittings will accommodate either $1/16$ " or $1/8$ " OD tubing and the hose barb will accommodate $1/16$ " ID tubing.

To use the Kel-F hose barb simply screw it into the drop former and push the tubing over its barbed end.

Two sets of flangeless nuts and ferrules are provided for use with the CF-2 Fraction Collector. The blue nut and ferrule are for use with $1/16$ " OD tubing. The cream colored nut and ferrule are for use with $1/8$ " OD tubing.

In each case the nut is made of Delrin and the ferrule is made of Tefzel. The Tefzel ferrule has excellent resistance to most solvents, although some halogenated hydrocarbons may cause it to swell. This is normally not a problem as long as the ferrule is replaced with the tubing. The Delrin nut, not a wetted part in normal operation, is subject to attack by many organic solvents

To attach the tubing to the drop former, first cut the end of the tubing square. For soft tubing, the use of a Spectrum tubing cutter is recommended; for hard (steel) tubing, use an HPLC tubing cutter.

Slide the nut and then the ferrule over the end of the tubing as shown in Figure 2-3. The narrower end of the ferrule should be away from the end of the tubing and toward the nut as shown.

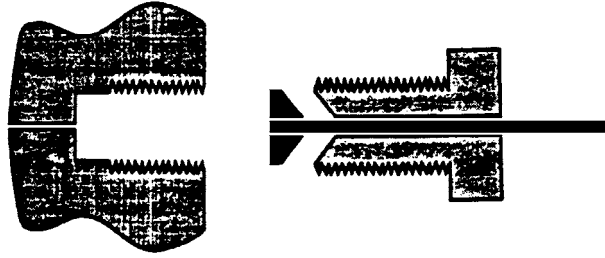

Figure 2-3. Assembling Flangeless Fittings

Remove the drop former from the drop counter assembly, and then press the tubing firmly into the fitting. Screw the nut into the fitting while keeping pressure on the fitting. Finger tightening of the nut is all that should be necessary to hold the tubing securely. Once the tubing is attached, replace the drop former into the drop counter assembly.

2.5 INSTALLING THE MAST PACKAGE

The optional Mast Package (Part No. 124874) provides 2 solid aluminum masts for supporting the four-column adapter, a UV Monitor optical unit, a shut-off or diverter valve, a small column, or other light-weight item. The Mast Package includes a bracket that mounts to the bottom of the Fraction Collector and two masts.

To install the Mast Package, disconnect all cables and fluid lines from the Fraction Collector. Be sure to disconnect the wall-mount transformer from the Fraction Collector. Also remove any tubes which contain fluid.

Rotate the Fraction Collector so that it rests on its side, then secure the mast bracket to the bottom of the Fraction Collector using the screws provided. The bracket mounts toward the rear of the Fraction Collector as shown in Figures 2-4A and 2-4B.

After the bracket is secure, place the Fraction Collector right-side-up and attach any cables and fluid lines. Finally, screw the two masts into the bracket. Do not use any masts other than those supplied.

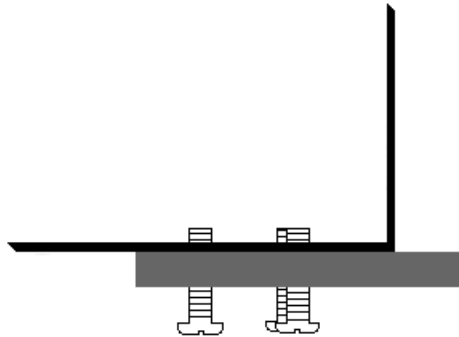

Figure 2-4A. Side View of Mast Bracket Installation.

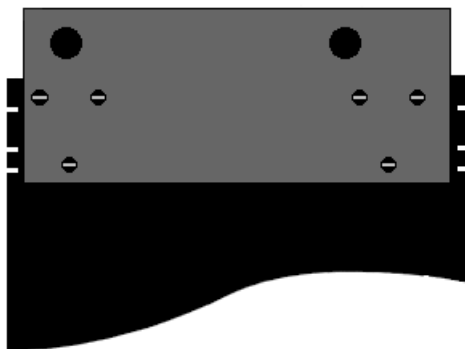

Figure 2-4B. Bottom View of Mast Bracket Installation.

2.6 INSTALLING A VALVE

Either a 3-Way Diverter Valve (Part No. 124849) or a 2-Way Shut-Off Valve (Part No. 124848) may be used with the Spectra/Chrom CF-2 Fraction Collector.

Each valve is provided complete with flangeless fittings for both $\frac{1}{16}$ " OD tubing and $\frac{1}{8}$ " OD tubing. Additionally, hose barbs for $\frac{1}{16}$ " ID tubing are available from Spectrum for use with these valves. Each valve is also provided with clips suitable for mounting it to a $\frac{1}{4}$ ", $\frac{1}{2}$ ", or $\frac{3}{4}$ " diameter mast.

In the recommended configuration a Mast Package (Part No. 124874) is used to support the valve, although any mast of an appropriate diameter may be used.

To use the valve, first select the proper clip and screw it to the base of the valve. Normally the $\frac{3}{4}$ " diameter clip is shipped attached to the valve; this is the clip that is used with the masts supplied in Spectrum's Mast Package. To use a clip other than the $\frac{3}{4}$ " diameter clip, the $\frac{3}{4}$ " diameter clip must first be removed.

The 3-Way Diverter Valve should be located as close as possible to the Fraction Collector's drop former. This minimizes the delay between the valve and the actual collection.

The 2-Way Shut-Off Valve may be located anywhere between the detector and the Fraction Collector. It is generally convenient, however, to locate it near the Fraction Collector.

To connect tubing to the valve using the flangeless fittings, select the blue nuts and ferrules for $\frac{1}{16}$ " OD tubing and the cream colored nuts and ferrules for $\frac{1}{8}$ " OD tubing.

The 2-Way Shut-Off Valve has two fluid ports, one labeled "IN" and the other "OUT". The valve should be plumbed so that fluid flows from the detector to the "IN" port and from the "OUT" port to the drop former.

The 3-Way Diverter Valve has three fluid ports, labeled "IN", "COLLECT", and "WASTE". The "IN" port should be plumbed to the outlet of the detector, the "COLLECT" port should be plumbed to the drop former, and a line should lead from the "WASTE" port to either a drain or a suitably sized waste container.

The ends of the tubing to be connected to the valve should first be cut square. Then slide a nut and ferrule over the end of the tubing as shown in Figure 2-3. The narrower end of the ferrule should be toward the nut as shown.

Now simply press the tubing firmly into the fitting and tighten the nut. Finger tightening of the nut is all that should be necessary.

After the tubing is attached, snap the mounting clamp over the mast and plug the valve's cord into the VALVE socket on the back of the Fraction Collector.

2.7 INSTALLING THE FOUR COLUMN ADAPTER

The Four Column Adapter (Part No. 124876) is an accessory for the CF-2 Fraction Collector which provides for the simultaneous collection of fractions from up to four columns. The Fraction Collector may only size fractions by time or volumes when the Four Column Adapter is used; the Four Column Adapter is not compatible with a drop counter. Spectrum does not recommend using the peak separator with the Four Column Adapter since only one solenoid valve may be used.

The Four Column Adapter consists of a set of special 4-place tube racks (28 tan and 1 orange) and a special dispensing head with 4 drop formers and a diverter tray to prevent spillage at the end of a run. Only the special tan and orange racks supplied should be used with the Four Column Adapter. These racks accommodate test tubes from 10 to 16 mm in diameter.

The optional Mast Package (Part No. 124874) is required for the operation of the Four Column Adapter.

The following procedure should be used to install the Four Column Adapter.

1. Remove the drop counter and test tube racks from the Fraction Collector. Leave the drop counter mast and rack sensor in place.
2. Place 28 of the tan test tube racks and the orange stop rack on the Fraction Collector.
3. Attach the optional masts (Part No. 124874) to the bottom of the Fraction Collector. See Section 2.5 for the details of the mast installation.
4. Mount the four column adapter's collection head to the right rear mast. Adjust the height of the collection head so that the diverter tray will clear the test tubes by about $\frac{1}{4}$ ".
5. Use the **START** and **MANUAL ADVANCE** keys on the front of the Fraction Collector to advance the racks until the first tube of the orange stop rack is next to the rack sensor assembly (in the "normal" filling position). Then press the **STOP** key.
6. Without changing the height of the collection head, adjust its lateral position so that each drop former is directly over a test tube in the last rack on the right hand side of the Fraction Collector.
7. The Four Column Adapter may be used with or without the action of the diverter tray. For use without the aid of the diverter tray, simply flip the tray up before collecting and operate the Fraction Collector normally.
8. If the diverter tray is to be used, only 28 fractions may be collected from each column. Fractions are not collected in the tan rack immediately following the orange stop rack. Instead, a rubber stopper is placed in the innermost tube of this rack to trip the diverter tray.

To use the diverter tray, simply advance the racks until the orange stop rack is at the rack sensor assembly as in step 5 above. Then tip up the diverter tray (so it is no longer under the drop formers) and place a stopper into the inboard test tube of the rack under the collection head (the tan rack following orange rack). The stopper should be high enough to contact the diverter tray at the end of the run and push it into position, as shown in Figure 2-5.



Figure 2-5. Four Column Adapter

A container of suitable capacity should be placed under the outlet of the diverter tray to collect the excess eluant.

Finally, press the **START** key to begin collection.

2.8 CONNECTION TO A SPECTRUM MODEL 280 UV MONITOR

Spectrum's Model 280 UV Monitor is capable of annotating the chromatogram with rack and tube change marks. Also, if the peak separator is to be used, the UV Monitor's output must be connected to the CF-2 Fraction Collector's signal input.

The CF-2 to Model 280 cable, part 142615 makes both connections. It connects from the REMOTE connector on the back of the CF-2 to the REMOTE connector on the back of the Model 280.

If you should wish to use the peak separator in the CF-2 and not have the tube change marks on the chromatogram, you can use cable 124865 to connect the RECORDER jacks on the back of the Model 280 to the SIGNAL and COMMON jacks on the back of the CF-2. The connectors on the 124865 cable are stackable, so that you can still connect the recorder output of the Model 280 to a chart recorder or data system.

2.9 CONNECTION TO A SPECTRUM PUMP

The CF-2 Fraction Collector can work with a Spectra/Chrom MP-1 or MP-2 Pump (see Page 45 for ordering information) to provide volumetric collection, to stop the pump between tubes, or to stop the pump at the end of a run.

Cable 124815 connects between the pump and the REMOTE connector on the Fraction Collector. This cable will stop the pump at the end of a run.

Cable 123859 also connects between the pump and the REMOTE connector on the Fraction Collector. This cable must be used for volumetric collection as it is the only one which transmits volume signals from the pump to the Fraction Collector. When this cable is used the pump will stop between tubes as well as at the end of the run.

2.10 DUST COVER

An optional Dust Cover is available for the Fraction Collector, This Dust Cover (Part No. 124858) protects the tubes from airborne dust particles. It can be removed and replaced without disturbing any connections to the Fraction Collector.

2.11 CASE TOP

Replacement case tops (Part No. 124852) are also available. These are provided with a full set of shuttles, but no racks; the racks for these must be ordered separately.

The replacement Case Tops make repeated runs much easier. After one run is complete, just unsnap the Case Top, unscrew the rack sensor, and remove an entire set of tubes at once. To start another run just snap a new Case Top into place, attach the rack sensor and begin. This eliminates the need to remove each tube or rack from the Fraction Collector separately.

2.12 RACKS

Four different rack types are available for the CF-2 Fraction Collector. These are listed in Table 2-2. All Racks come in complete sets that include a red stop rack.

2.13 REPLACEMENT FITTINGS

A kit containing a variety of replacement fittings is available as Part No. 124839. This package contains an assortment of flangeless fittings and hose barbs as well as a glass sleeve for the drop counter.

TABLE 2-1. CABLE USAGE

Part No.	Connects to	Function
124865	UV Monitor	Provides signal for peak separator.
142615	UV Monitor	Provides signal for peak separator and event marks on chromatogram.
124815	Pump	Stops pump at end of run.
123859	Pump	Volumetric fraction size and stops pump between tubes and at end of run.

TABLE 2-2. AVAILABLE RACK SETS

Part No.	Tube Size	Tubes/Rack	Fraction Collector Capacity
124853	12 to 13 mm	6	174 tubes in 29 racks
124854	10 to 16 mm	4	116 tubes in 29 racks
124855	17 to 18 mm (minivials)	4	116 tubes in 29 racks
124856	28 to 29 mm (scintillation vials)	3	42 tubes in 14 racks

3 OPERATION WITHOUT THE PEAK SEPARATOR

3.1 INTRODUCTION

The CF-2 Fraction Collector has two distinctly different "personalities". Operation with the peak separator active is different from operation with the peak separator inactive.

To use the peak separator you must purchase an optional 3-Way Diverter Valve (Part No. 124849). When the peak separator is inactive, you may use the 3-Way Diverter Valve, a 2-Way Safety Valve (Part No. 124848), or no valve.

This section describes the operation of the Fraction Collector with the peak separator inactive. Section 4 describes the features available while the peak separator is in use.

3.2 GENERAL INFORMATION

Many of the keys on the Fraction Collector work the same all of the time. These are:



Alternately switches the Fraction Collector between ON and STANDBY. When ON, the indicator next to the key is illuminated.

PROGRAM

Pressing the program key will display a menu you can use to reconfigure the Fraction Collector.

HELP

Pressing the help key displays a context-sensitive help message and a reference for further help in Section 5 of this manual.

MANUAL VALVE

Controls an optional 2-Way Safety or 3-Way Diverter Valve. The valve is set to collect eluant when the indicator next to the key is illuminated.

MANUAL ADVANCE

Pressing the manual advance key will advance the racks by 1 tube position. Holding the key down will cause the racks to continually advance.

Other keys have functions which are only available some of the time. These keys are:

UNDO ENTRY

When entering a number, pressing the clear key will erase what you have entered and restore the previous value. This works only when entering a number.

START

The start key resumes sample collection. Pressing the start key twice resets the tube and rack numbers.

STOP

When the Fraction Collector is collecting, pressing the stop key once will pause the collection. You may resume by pressing the start key.

A - D

The A, B, C, and D keys are "soft" keys. When a word in all capital letters is displayed above one of these keys, pressing it will select the choice associated with that word.

1 - 9



Used to make numeric entries. When both a greater than and a less than symbol (> <) are flashing, a numeric entry is expected. Enter the desired number and then press the **D** key.

3.3 FRACTION COLLECTOR SETUP

The Fraction Collector is shipped with the peak separator inactive. If you are unsure whether the peak separator on your Fraction Collector is operating and you wish to disable it, the following

procedure may be used.

To select the "personality" the Fraction Collector has when the peak separator is inactive, first connect the Fraction Collector to mains power and turn it off (by pressing the  key if necessary).

Next, turn the Fraction Collector on by pressing and releasing the  key. After releasing the  button, immediately press and hold down the **C** key until the Fraction Collector prompts you to set the time format. Press the **A** key to have times displayed as minutes and tenths of minutes. Press the **B** key to have times displayed as minutes and seconds.

Following the time format selection, you will be asked if a valve is present. Press the **A** key if you will not be using either a 3-way Diverter valve or a 2-way shut-off valve. Press the **B** key if you will be using a Spectra/Chrom Solenoid Valve with your CF-2 Fraction Collector. If you select **A** for No valve, you will not be asked the remaining questions in this setup section.

If you will be using a solenoid valve with your CF-2 Fraction Collector, you will now be asked to set the valve delay time. The valve delay time is used when collecting fractions based on time or pumped volumes. In these cases, when the selected fraction size has been accumulated the valve is not immediately switched. The valve delay time is then allowed to elapse prior to advancing the tubes. This helps to keep drops from falling between the tubes.

The valve delay time is set in units of 50 ms. Solenoid valves sold by Spectrum (Reorder Nos. 124848 and 124849) operate in less than 20 ms. Setting the valve delay time to 1 allows 30 ms for the fluid to compress and rebound at the valve outlet. This is sufficient for most installations.

The final setup question asks if you wish to use the peak separator. Since you do not wish to use the peak separator press the **A** key to select NO.

3.4 NORMAL OPERATION

During the normal operation of the Fraction Collector with the peak separator inactive, the display should be similar to that illustrated in Figure 3-1.

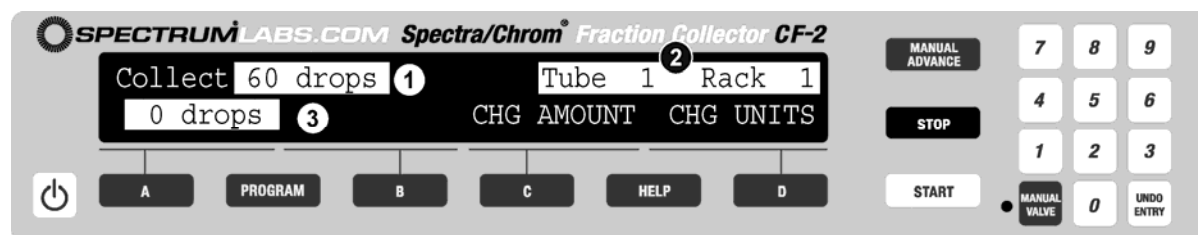

Figure 3-1. Normal Display with Peak Separator Off. (1) Amount to collect, (2) Tube Position, (3) Amount in Current Tube.

The display may show that the Fraction Collector has been paused. Pressing the **STOP** key while collecting fractions will pause the Fraction Collector and close any attached solenoid valve. Press the **START** key once to resume. Press the **START** key twice to reset the Rack and Tube numbers.

To change the amount to collect in each tube press the **C** key, then use the numeric keys to enter the amount to collect and press the **D** key to confirm your entry. The Fraction Collector will continue to operate while you are entering the new value.

To change between time units, drops, and volume units, press the **D** key, then press the **B** key to collect by drops, the **C** key to collect pumped volumes, or the **A** key to collect based on time intervals. If you are collecting by drops you must have the drop counter (supplied with instrument) plugged into the PUMP OR DROP COUNT connector on the back of the Fraction Collector. Similarly, if you are collecting by pumped volumes you must have the appropriate cable (Part No. 123859) plugged into both the Fraction Collector and the pump.

When the eluant stream has a relatively constant flow rate Spectrum generally recommends collecting based on time, rather than volumes or drops. For small volumes, however, where a single drop is a considerable portion of the fraction size, drop counting is the preferred method. (Note: The drop counter operates at a maximum of 5 drops per second, higher drop rates will give inconsistent fraction sizes.) Collection based on pumped volumes is only recommended in situations where the pump speed is expected to vary during the course of a chromatogram.

3.5 STOP RACK

Each of the four different rack sets come complete with a full set of white racks and a single red stop rack. The last position of the red stop rack will stop the Fraction Collector when it reaches the filling position. When the Fraction Collector is connected to a pump with a 124873, 123859, or 124815 cable, the pump will also stop when this position is reached.

4 OPERATION WITH THE PEAK SEPARATOR

4.1 INTRODUCTION

The Fraction Collector has two distinctly different "personalities". Operation with the peak separator active is different from operation with the peak separator inactive.

In order to use the peak separator you must purchase an optional 3-Way Diverter Valve (Part No. 124849).

The 3-Way valve is connected to the Fraction Collector as described in Section 2.6.

This section describes the operation of the Fraction Collector with the peak separator active. Section 3 describes the features available when the peak separator is not active.

4.2 GENERAL INFORMATION

Many of the keys on the Fraction Collector work the same all of the time. These are:



Alternately switches the Fraction Collector between ON and STANDBY. When ON, the indicator next to the key is illuminated.

PROGRAM

Pressing the program key will display a menu you can use to reconfigure the Fraction Collector.

HELP

Pressing the help key displays a context-sensitive help message and a reference for further help in Section 5 of this manual.

MANUAL VALVE

Controls the 3-Way Diverter Valve. The valve is set to collect eluant when the indicator next to the key is illuminated.

MANUAL ADVANCE

Pressing the manual advance key will advance the racks by 1 tube position. Holding the key down will cause the racks to continually advance.

Other keys have functions which are only available some of the time. These keys are:

UNDO ENTRY

When entering a number, pressing the clear key will erase what you have entered and restore the previous value. This works only when entering a number.

START

The start key resumes sample collection. Pressing the start key twice resets the tube and rack numbers.

STOP

When the Fraction Collector is collecting, pressing the stop key once will pause the collection. You may resume by pressing the start key.

A - D

The A, B, C, and D keys are "soft" keys. When a word in all capital letters is displayed above one of these keys, pressing it will select the choice associated with that word.



1 - 9

Used to make numeric entries. When both a greater than and a less than symbol (> <) are flashing, a numeric entry is expected. Enter the desired number and then press the **D** key.

4.3 FRACTION COLLECTOR SETUP

The Fraction Collector is shipped with the peak separator inactive. The following procedure may be used to enable the peak separator.

To select the "personality" of the Fraction Collector when the peak separator is active, first connect the Fraction Collector to mains power and turn it off (by pressing the  key if necessary).

Next, turn the Fraction Collector on by pressing and releasing the  key. After releasing the  key, immediately press and hold down the **C** key until the Fraction Collector prompts you to set the time format. Press the **A** key to have times displayed as minutes and tenths of minutes. Press the **B** key to have times displayed as minutes and seconds.

Following the time format selection, you will be asked if a valve is present. The peak separator should only be used in conjunction with a 3-Way Diverter Valve. Press the **B** key since you will be using a Spectra/Chrom valve with the Fraction Collector.

You will now be asked to set the valve delay time. The valve delay time is used when collecting fractions based on time or pumped volumes. In these cases, when the selected fraction size has been accumulated the valve is immediately switched. The valve delay time is allowed to elapse prior to advancing the tubes. This helps to keep drops from falling in between the tubes.

The valve delay time is set in units of 50 ms. Both solenoid valves sold by Spectrum for use with the CF-2 Fraction Collector (Part Nos. 124848 and 124849) operate in less than 20 ms. Setting the valve delay time to 1 allows 30 ms for the fluid to compress and rebound at the valve outlet. This is sufficient for most installations.

The final setup question asks if you wish to use the peak separator. Since you wish to use the peak separator press the **B** key to select YES.

4.4 NORMAL OPERATION

During the normal operation of the Fraction Collector with the peak separator active, the display should be similar to that illustrated in Figure 4-1.

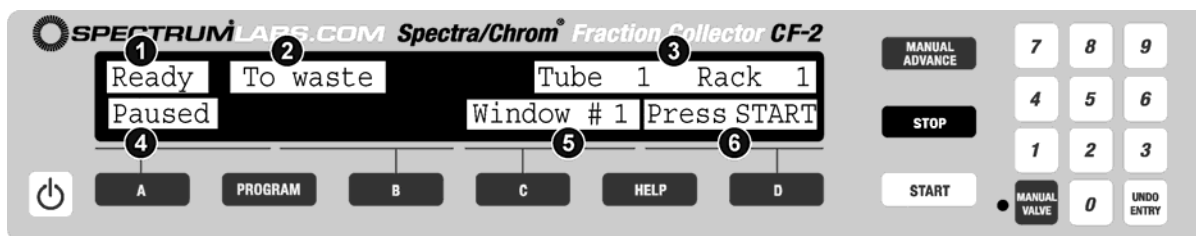

Figure 4-1. Normal Display with Peak Separator On

There are several areas in the normal display. Area 1 will show the status of the peak detector. It will be "Ready" when the Fraction Collector is stopped but ready to start, "Run" when the Fraction Collector is running and the peak detector is off, "Peak" during a peak, "No pk" between peaks, and "End" at the end of a run.

Area 2 in Figure 4-1 will show the state of the 3-Way Diverter Valve. It will read either "To waste" or "Collect".

Area 3 in Figure 4-1 shows the current tube and rack position. The tube number does not start over with a rack change, but is cumulative for the entire run.

Area 4 in Figure 4-1 shows the amount collected in the current tube. When no material is being collected, other status information, such as the "Paused" message shown, is displayed here.

Area 5 in Figure 4-1 shows the status of the time windows. This will either indicate which time window the Fraction Collector is in, or show "No wndws" if no time windows are programmed.

Area 6 in Figure 4-1 shows the elapsed run time. When ready to start a run the phrase "Press START" will appear and at the end of a run the end time will be displayed.

Prior to beginning collection several parameters will need to be set. These are grouped into several areas: peak detection, time windows, fraction size, and instrument setup. In addition, the memory capabilities of the Fraction Collector may need to be understood.

4.5 PEAK DETECTION

The Spectra/Chrom CF-2 Fraction Collector includes two peak detectors as part of its peak separator. It includes both a level sensitive detector and a slope sensitive detector.

The level detector senses peaks based on the absolute detector signal. Any time the detector output is above the user-specified threshold value (set in terms of percent of full scale), a peak is declared; whenever the detector output falls below the threshold the system is assumed to be between peaks.

The slope detector senses peaks based on the rate of change of the detector signal. When the rate of change of the detector signal exceeds the user-specified threshold level (set in terms of an expected peak width), a peak is declared. After the start of a peak is found, the detector will look for the top and then the end of the tail of the peak before signaling the end of the peak.

To program the two peak detectors, first press the **STOP** key once or twice until the Fraction Collector is back at the "Ready" state ("Ready" is displayed in area 1 of the display, Figure 4-1). Then press the **PROGRAM** key to display the first program menu followed by the **A** key to program the Peak Detectors.

The first step in programming the peak detectors is to select which will be active. Press the **A** key to disable both peak detectors (the entire run will be considered a peak). Press the **B** key to select only the level detector. Press the **C** key to select only the slope detector. Press the **D** key to use both the level and slope detectors together. When both of the detectors are on, the Fraction Collector will only respond to peaks which are seen by both detectors.

The detector output must be connected to the signal input of the Fraction Collector in order for either of the peak detectors to operate. Use cable 124865 for this purpose.

If you turned the peak detectors off (by pressing the **A** key) you will now be returned to the first program menu. Press the **START** or **PROGRAM** key to return to the "Ready" state.

If you turned on the level detector (by pressing either the **B** or **D** keys) you will need to set the level detector threshold. Simply use the numeric keys to enter the percent of the full-scale detector output to use as the threshold. Then press the **D** key to complete your answer.

If you turned on the slope detector (by previously pressing either the **C** or **D** keys) you will need to set the expected peak width. Press the **A** key to select a longer peak width or the **B** key to select a shorter one. Press the **D** key when you are satisfied with your selection.

The two remaining slope detector parameters are the peak broadening parameter and the sensitivity. When doing most isocratic chromatography, the peaks later in the chromatogram will be wider than those early in the chromatogram. Select "Yes" for "Allow for peak broadening" if you wish to have the expected peak width be automatically extended during the course of the chromatogram; otherwise select "No".

The slope detector sensitivity selects the expected peak height. Select "High" if you expect peaks less than 50% of full-scale; select "Low" if you expect all peaks to be greater than 50% of full-scale.

In general the peak broadening parameter and the sensitivity will have only a slight affect on the operation of the peak detector.

4.6 TIME WINDOWS

The time windows feature allows certain portions of a chromatogram to be treated differently from others. It is most useful for excluding certain extraneous peaks (such as the initial solvent front) from collection. It may also be used, however, to control collection in the absence of a detector (i.e. when the chromatography is well developed) or to collect species that are invisible to the detector.

Each time window has a starting time, an ending time, and a status associated with it. For the first time window the starting time is 0:00 (the start of the run). For each of the other time windows, the starting time will be the ending time of the previous window. The last time window will have an ending time of 0:00 to signal to the Fraction Collector that it is the end of the list.

Each window may have a status of COLLECT, SKIP, or PEAK ONLY. During COLLECT windows, all of the eluant is collected, regardless of whether a peak is detected. During SKIP windows, nothing is collected. During PEAK ONLY windows the Fraction Collector will only collect eluant while a peak is detected by the peak detector module.

During COLLECT windows the peak separator is still active. Separate fraction sizes can be set (see Section 4.7) for the peak and non-peak material collected.

To program the time windows, first press the **STOP** key once or twice until the Fraction Collector is back at the "Ready" state ("Ready" is displayed in area 1 of the display, Figure 4-1). Then press the **PROGRAM** key to display the first program menu followed by the **B** key to program the time windows.

The display should now be similar to that illustrated in Figure 4-2. The display shows (1) the consecutive number of the window being programmed, (2) the starting time of the window, (3) the ending time set for the window, and (4) the status of the window.

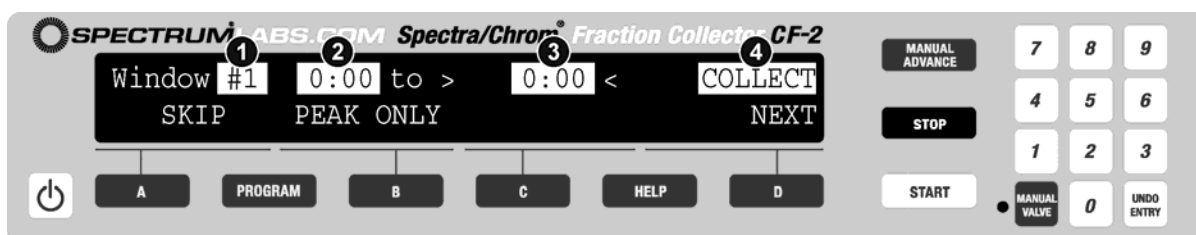

Figure 4-2. Programming Time Windows

To change the status of the window, press the **A** or **B** key until the desired status is displayed. To set the ending time of the window press the numeric (0-9) keys until the desired time is displayed. If the ending time is set to be before the starting time, the previous window will be assumed to be the last window.

When the desired ending time and status are displayed, press the **D** key to proceed to the next window.

After the last window is programmed, set the ending time of the next window to 0:00 and then press the **D** key. This will end the list of windows used. To "unprogram" the windows, set the end time of the first window to 0:00.

NOTE: If no time windows are used, the Fraction Collector will collect all of the eluant, as if a COLLECT window had been programmed. To change this action, you may program a single time window from 0:00 to 999:59 with a status of PEAK ONLY. The Fraction Collector will then only collect the peak portions of the chromatogram.

4.7 FRACTION SIZE

Two different fraction sizes can be programmed for collection. The fraction size used for the collection of peaks may be set independently of that used for non-peaks. In addition, three variables are available for controlling the fraction size: drop count, time, and pumped volumes.

To set the fraction sizes, first press the **STOP** key once or twice until the Fraction Collector is back at the "Ready" state ("Ready" is displayed in area 1 of the display). Then press the **PROGRAM** key to display the first program menu followed by the **C** key to program the Fractions.

The display should now be similar to that illustrated in Figure 4-3. Here you must select which variable to use for collecting fractions. Press the **A** key to size fractions based on time, press the **B** key to size fractions based on the number of drops, or press the **C** key to size fractions based on the number of pumped volumes.

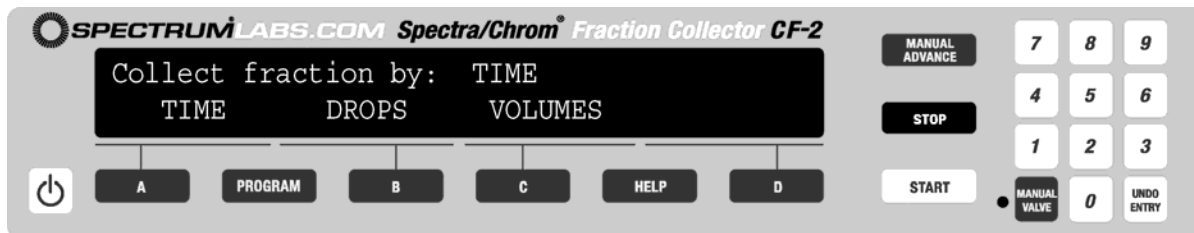

Figure 4-3. Programming Fraction Size

To size fractions based on the number of drops, the drop counter must be plugged into the back of the Fraction Collector. The maximum count rate is five drops per second. If you will be pumping faster than this you must select either time or volumes instead.

To size fractions based on the number of pumped volumes, you must be using a Spectra/Chrom MP-1, or MP-2 Pump. You must also connect the pump to the Fraction Collector with cable 123859.

After you have selected the variable to use for sizing fractions, you will be prompted to enter the peak fraction size. Enter the amount you wish to collect during a peak. If you have turned off the peak detector (see Section 4.5) the entire chromatogram will be considered a peak. After the desired fraction size is entered, press the **D** key.

Once the peak fraction size is set you will be asked to enter the non-peak fraction size. This is the amount to collect in each tube while between peaks. If you have set the time windows parameters so that non-peaks will not be collected (see Section 4.6), the non-peak fraction size is irrelevant. Since you may alter your program at some future time, the non-peak fraction size may still be set. Once you have entered the desired value, press the **D** key.

The final fraction size variable is whether to continue after the end of the time windows. You may set the Fraction Collector to stop (send all eluant to waste) after the end of the last time window or to wait until the red stop rack is reached. Press the **A** key to have the Fraction Collector stop at the end of the programmed time windows; press the **D** key to have the Fraction Collector continue until the red stop rack is reached.

If you select AT RED RACK, all of the time after the last time window until the last position of the red stop rack is reached will have a status of COLLECT. Both the peak and non-peak fractions will be collected.

If you select AFTER LAST WINDOW, the Fraction Collector will still stop if the last position in the red stop rack is reached prior to the end of the time windows. This prevents the Fraction Collector from overlaying previously collected material.

4.8 FLOW DELAY

In some situations, the Fraction Collector may be located a considerable distance from the UV Monitor. This can create an error in selecting peak and non-peak eluent since the signal from the UV Monitor would then represent the composition before the eluant actually reached the Fraction Collector.

Normally, this represents an insignificant problem since the peak will be much larger than the volume of the tubing between the UV Monitor and the Fraction Collector. In those situations where the peaks

are much shorter than the volume of the tubing between the UV Monitor and the Fraction Collector, this delay may be compensated for by the peak separator in the Fraction Collector.

The flow delay programmed into the Fraction Collector should be the amount of time required for fluid to travel between the UV monitor and the 3-Way Diverter Valve used with the Fraction Collector. The loss between the 3-Way Diverter Valve and drop former cannot be accounted for; therefore, the 3-Way Diverter Valve should be mounted as close as possible to the drop former.

A formula which may be used to calculate the flow delay is found in Section 5.39. To enter the flow delay, first press the **STOP** key once or twice until the Fraction Collector is back at the "Ready" state ("Ready" is displayed in area 1 of the display, Figure 4.1). Then press the **PROGRAM** key to display the first program menu, the **D** key to show the second program menu, and finally the **B** key to program the flow delay. You will be prompted to enter the desired flow delay. Simply press the numeric keys until the desired time is entered and then the **D** key to store it.

Enter a time of 0 to disable the flow delay.

4.9 PROGRAM SAVE AND RECALL

The Fraction Collector can store 4 programs in addition to the one being used. This makes it possible for a single Fraction Collector to be routinely used for several different tasks.

To save the current program for later retrieval or to retrieve a previously stored program, first press the **STOP** key once or twice until the Fraction Collector is back at the "Ready" state ("Ready" is displayed in area 1 of the display, Figure 4.1). Then press then **PROGRAM** key to display the first program menu, the **D** key to show the second program menu and the **C** key to select memory operations.

The display should then appear similar to that illustrated in Figure 4-4.

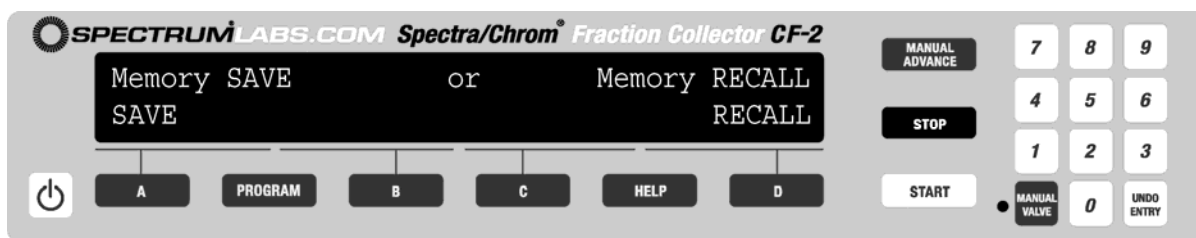

Figure 4-4. Saving/Recalling Programs

To save the current program for later use press the **A** key. To retrieve a previously stored program press the **B** key.

After pressing **A** or **B** you will be asked which memory to use. The memories are named **A**, **B**, **C**, and **D**. Press the key which corresponds to the name of the memory you wish to use for storing or recalling.

4.10 PREVIEW

One of the most useful features of the Spectra/Chrom CF-2 Fraction Collector is the automatic preview. When the automatic preview is enabled, the current program will be displayed immediately prior to starting a run. This makes it easy to spot any errors and correct them before the sample is imperiled.

In some circumstances, however, the delay while the preview is occurring is undesirable. To avoid this delay, the automatic preview can be disabled.

To disable or enable the automatic preview feature, first press the **STOP** key once or twice until the Fraction Collector is back at the "Ready" state ("Ready" is displayed in area 1 of the display, Figure

4.1). Then press the **PROGRAM** key to display the first program menu, the **D** key twice to show the third program menu and finally the **B** key to select preview.

The display should appear similar to that illustrated in Figure 4-5.

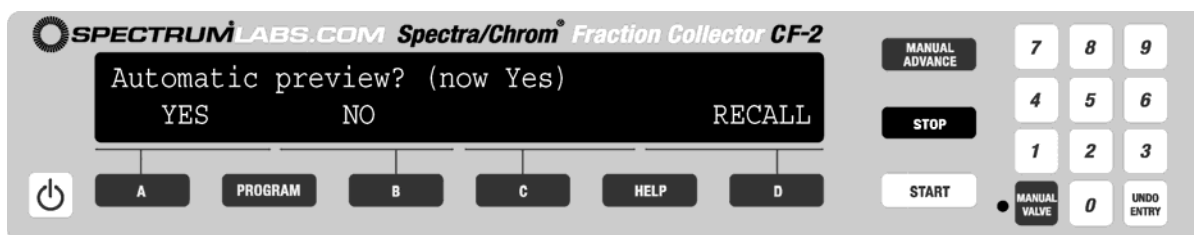

Figure 4-5. Preview Selection

Press the **B** key to disable the automatic preview.

Press the **A** key to enable the automatic preview. This will also cause the preview display to occur, showing you the current program.

Press the **D** key to cause the preview display to occur, showing you the current program. Pressing the **D** key will not change the state of the automatic preview.

4.11 SETUP CHANGES

The two most common configuration parameters can easily be changed without turning the Fraction Collector off; the format for displaying time values and the valve delay time. The other setup parameters may only be changed as described in Sections 3.3 and 4.3.

To change the format for time values or the valve delay time, first press the **STOP** key once or twice until the Fraction Collector is back at the "Ready" state ("Ready" is displayed in area 1 of the display, Figure 4.1). Then press the **PROGRAM** key to display the first program menu, the **D** key twice to show the third program menu and finally the **C** key to select setup.

You will then be prompted to select the desired format to use when displaying time values. Press the **A** key to have times displayed as minutes and tenths of minutes. Press the **B** key to have times displayed as minutes and seconds.

Next, you will now be prompted to set the valve delay time. The valve delay time is used when collecting fractions based on time or pumped volumes. In these cases, the valve is immediately switched when the selected fraction size has been accumulated. The valve delay time is then allowed to elapse prior to advancing tubes. This helps to keep drops from falling in between the tubes.

The valve delay time is set in units of 50 ms. Both solenoid valves sold by Spectrum for use with the CF-2 Fraction Collector (Part No. 124848 and 124849) operate in less than 20 ms. Setting the valve delay time to 1 allows 30 ms for the fluid to compress and rebound at the valve outlet. This is sufficient for most installations.

5 HELP MESSAGES

5.1 INTRODUCTION

When the **HELP** key is pressed, the display will first show a 2 digit number and then a brief help message. The number allows you to look up the message in this section of the manual. Simply precede the number by "5." and look up the information here. More complete information is provided here than could be shown on the Fraction Collector display.

5.11

The Spectra/Chrom[®] CF-2 Fraction Collector contains an internal nickel-cadmium battery which provides power to allow the Fraction Collector to retain information while it is unplugged. This battery is continually charged while the Fraction Collector is plugged in.

When new, this battery should provide power for up to 1 month (depending storage conditions). If the Fraction Collector is left unplugged for an excessive period of time, this message will be displayed when the Fraction Collector is first turned on. You must press the **A** key to advance past this message.

5.12

The size of the collected fractions may be set in terms of the number of drops to collect, the amount of time for which to collect, or the number pumped volumes to collect.

To size fractions based on the number of drops, the drop counter must be plugged in to the back of the Fraction Collector. It connects to the PUMP OR DROP COUNT connector (item 2 in Figure 1-2). The drop counter pump can only count 5 drops per second or less. If you will be pumping faster than 5 drops per second you will only be able to size fractions by time or volumes. Press the **A** key to size fractions by drop count.

To size fractions based on the amount of time for which to collect, press the **B** key.

If you are using a Spectra/Chrom[®] MP-1, or MP-2 Pump you can collect fractions based on the number of pumped volumes. To do this you must use cable 123859 to connect the pump to the PUMP OR DROP COUNT connector on the back of the Fraction Collector (item 2 in Figure 1-2), and press the **C** key to select VOLUMES. The relationship between volumes and volume pumped may be found in the manual for your pump or in Section 6.10 of this manual.

5.13

There are two common conventions for working with time in chromatography. The Spectra/Chrom-CF-2 Fraction Collector is capable of working with either. If you prefer to deal with time in terms of minutes and tenths of minutes press the **A** key; if you prefer to deal with time in terms of minutes and seconds press the **B** key.

5.14

Two different valves are available for use with the CF-2 Fraction Collector. One is a 2-Way Shut-Off Valve (Part No. 124848) and the other a 3-Way Diverter Valve (Part No. 124849). Neither is supplied with the Fraction Collector.

We strongly recommend that a 3-Way Diverter Valve be used if you intend to operate the peak-separator feature of the Fraction Collector.

If you will not be using a valve press the **B** key. If you will be using a valve press the **A** key.

5.15

When sizing fractions by time or volumes, the Fraction Collector delays the start of its movement when a valve is present. This gives the valve time to operate so that no liquid drops between tubes.

The valves sold by Spectrum (Reorder Nos. 124848 and 124849) operate in less than 50 ms. Simply press the **1** key and then the **D** key to set the time to 50 ms.

5.17

The Spectra/Chrom CF-2 Fraction Collector can operate either with its internal peak separator active or as a simple Fraction Collector. We recommend using the peak separator feature only if you are also using an optional 3-Way Diverter Valve (Part No. 124849). The top line of the display indicates whether the peak separator is currently in use.

Press the **A** key to use the Fraction collector without using its internal peak separator. Press the **B** key to use the peak separator.

5.18

Press the **START** key to begin fraction collection and the **STOP** key to stop collection.

Press the **C** key if you wish to change the amount to be collected in each tube.

Press the **D** key to change between drops, pumped volumes, and time as the basis for collection.

5.19

Enter the amount to collect in each tube. If you are sizing fractions by drops, enter the number of drops. If you are sizing fractions by time, enter the length of time for which to collect. If you are sizing fractions by volumes enter the number of pumped volumes to collect. See Section 6.10 or your pump's manual for instructions for converting pumped volumes into actual collected volumes.

To enter the fraction size press the numbered keys until the desired value is displayed, then press the **D** key.

If the desired fraction size is already displayed, simply press the **D** key.

5.20

The size of the collected fractions may be set in terms of the number of drops to collect, the amount of time to collect, or the number of pumped volumes to collect.

To size fractions based on the number of drops, the drop counter must be plugged in to the back of the Fraction Collector. It connects to the PUMP OR DROP COUNT connector (item 2 in Figure 1-2). The drop counter can only count 5 drops per second or less. If you will be pumping faster than 5 drops per second you will only be able to size fractions by time or volumes. Press the **B** key to size fractions by drop count.

To size fractions based on the amount of time for which to collect, press the **D** key.

If you are using a Spectra/Chrom MP-1, or MP-2 Pump you can collect fractions based on the number of pumped volumes. To do this you must use cable 123859 to connect the pump to the PUMP OR DROP COUNT connector on the back of the Fraction Collector (item 2 in Figure 1-2), and press the **C** key to select VOLUMES. The relationship between volumes and volume pumped may be found in the manual for your pump or in Section 6.10 of this manual.

5.22

The Fraction Collector is now ready to begin collecting. From here you may begin collection or alter the peak separator's program.

To change the program in the peak separator press the **PROGRAM** key. This will display the first program menu.

To begin collection press the **START** key.

5.23

The Fraction Collector is now collecting fractions using a preset peak separator program. Press the **STOP** key once to pause the collection or twice to end the run.

If you only press the **STOP** key once you may resume the run from where it was interrupted by pressing the **START** key once. If you press the **STOP** key twice you can only run the program from its beginning.

5.24

You are now ready to edit the peak separator program. Press the **A** key to control the peak detector. After you press the **A** key you will be able to turn on and off both the level detector and the slope detector.

Press the **B** key to program the time windows. After you press the **B** key you will be able to program the ten available time windows.

Press the **C** key to set the fraction size. You will then be able to set the fraction size as well as whether times, drops, or volumes should be used as the fraction basis.

Press the **D** key to show the next page of this menu. After pressing the **D** key you will be able to: set the flow delay; save the current program or recall a previous one; preview the program; or change the setup of the Fraction Collector.

If you are through editing the program press the **START** key to be ready to start the run. The **START** key will not start the run while this menu is displayed.

5.25

This is the second section of the peak separator program menu. Press the **A** key to return to the previous page of the menu.

Press the **B** key to set the flow delay. The flow delay is the time required for liquid to travel from the UV Monitor (or other detector) to the drop former or valve. This will normally be a very short time and could easily be ignored with only a small effect on the collection.

Press the **C** key to save the current program or to recall a previous program. The Fraction Collector can save 4 programs for later use.

Press the **D** key to show the final page of this menu. After pressing the **D** key you will be able to preview the program or change the instrument setup.

If you are through editing the program press the **START** key to be ready to start the run. The **START** key will not start the run while this menu is displayed.

5.26

From this menu you may elect to either save the current program for later use or retrieve a previously saved program.

If you wish to save the current program press the **A** key. To retrieve a previously saved program press the **D** key.

If you do not want to save the current program or retrieve a previously saved program press either the **START** or **PROGRAM** key.

5.27

The Fraction Collector can save 4 programs for later use. The saved programs are named **A**, **B**, **C**, and **D**.

To save the current program for later use, simply press the letter of the name you wish to use to save it.

If you do not want to save the current program press either the **START** key or the **PROGRAM** key.

5.28

The Fraction Collector can save 4 programs for later use. The saved programs are named **A**, **B**, **C**, and **D**.

To retrieve a previously stored program simply press the letter of the name you used to save it.

If you do not wish to retrieve a previously stored program press either the **START** key or the **PROGRAM** key.

5.29

The Spectra/Chrom CF-2 Fraction Collector contains both a level detector and a slope detector. Either or both of these may be used in any program.

The top line of the display shows which of the two peak detectors is currently selected.

Press the **A** key to disable both peak detectors. When OFF is selected in this manner the entire chromatogram will be considered to be a peak.

Press the **B** key to enable only the level detector. You will be prompted to enter the level detector threshold in terms of percent full-scale. Any time the input signal is above the set level the Fraction Collector will consider a peak to be present.

Press the **C** key to enable only the slope detector. You will be prompted to enter the peak width for detection. The slope detector senses the derivative of the input signal. When the derivative of the input signal indicates the beginning of a peak the Fraction Collector will consider a peak to be present. The Fraction Collector will then look for an appropriate negative slope and leveling off region to locate the end of the peak.

Press the **D** key to enable both the slope detector and the level detector. When BOTH is selected in this manner, the Fraction Collector will only consider a peak to be that part of the chromatogram that satisfies BOTH the level detector and the slope detector.

5.30

The level detector is programmed for peak detection in terms of a level threshold. The level threshold is a percentage of the full-scale absorbance.

If you have zeroed your detector so that the baseline is at zero volts, simply set the threshold to the level at which you believe peaks begin. You will probably need to re-zero your detector prior to each sample. If your baseline drifts significantly it may cross the threshold and be considered a peak.

We recommend the use of the slope detector over the threshold detector since it is more immune to the effects of baseline drift.

5.31

The slope detector is programmed by setting the expected peak width. Press the **A** key to select a longer peak width; press the **B** key to select a shorter peak width. Press the **D** key when the desired peak width is displayed.

The exact peak width need not be set. The slope detector will work reasonably well if the programmed peak width is within a factor of 5 (.2x to 5x) of the actual peak width.

5.32

In gel filtration experiments, the peaks which elute later will generally be broader than those that appear earlier. The Spectra/Chrom CF-2 Fraction Collector can be set to allow for this. Pressing the **A** key to select YES for "Allow for peak broadening?" will cause the slope detector to gradually increase the expected peak width during the course of the chromatogram. Pressing the **B** key to select NO will cause the slope detector to use a constant expected peak width during the entire chromatogram.

If you select Yes, so that the slope detector expects peaks to broaden, the expected peak width, set previously, should be set to the peak width of the first peak.

5.33

The slope detector has two different sensitivity levels, high and low. The high is tuned for the detection of smaller (25% full-scale) peaks; the low sensitivity is tuned for the detection of larger (75% full-scale) peaks.

Press the **A** key to select the high sensitivity range or the **D** key to select the low sensitivity range. If you expect both large and small peaks in the same chromatogram, select the high sensitivity range.

5.34

Use the number keys to set the end time for this window and the **A** or **B** key to set the desired status for this time window. Then press the **D** key.

Each time window may be set to COLLECT, SKIP, or PEAK ONLY. If the status is set to COLLECT, then all of the eluant will be collected during the time window. The peak separator (if turned on) will still advance one tube at the start and end of each peak and use the appropriate (peak vs. non-peak) fraction size.

If the status is set to SKIP, then no eluant will be collected during the time window; all of the eluant will be sent to waste via an optional 3-Way Diverter Valve. One empty tube will be left to mark this window. If a 3-Way Diverter Valve is not installed, do not select SKIP.

If the status is set to PEAK ONLY, then only the peaks will be collected during the time window. Non-peak eluant will be sent to waste via an optional 3-Way Diverter Valve. If a 3-Way Diverter Valve is not installed, do not select PEAK ONLY.

To end the list of time windows, set the end time to zero (or to any time before the beginning of the window).

Be sure to press the **D** key when all of the answers are correct.

5.35

The size of the collected fractions may be set in terms of the number of drops to collect, the amount of time to collect, or the number of pumped volumes to collect.

To size fractions based on the number of drops, the drop counter must be plugged in to the back of the Fraction Collector. It connects to the PUMP OR DROP COUNT connector (item 2 in Figure 1-2). The drop counter can only count 5 drops per second or less. If you will be pumping faster than 5 drops per second you will only be able to size fractions by time or volumes. Press the **B** key to size fractions by drop count.

To size fractions based on the amount of time to collect, press the **D** key.

If you are using a Spectra/Chrom MP-1, or MP-2 Pump you can collect fractions based on the number of pumped volumes. To do this you must use cable 123859 to connect the pump to the PUMP OR DROP COUNT connector on the back of the Fraction Collector (item 2 in Figure 1-2), and press the **C** key to select VOLUMES. The relationship between volumes and volume pumped may be found in the manual for your pump or in Section 6.10 of this manual.

5.36

Enter the amount to collect in each tube during a peak. If the peak separator will not be used, this is the size of all of the fractions to collect.

If you are sizing fractions by drops, enter the number of drops. If you are sizing fractions by time, enter the length of time to collect. If you are sizing fractions by volumes, enter the number of pumped volumes to collect. See Section 6.10 or your pump's manual for instructions to convert pumped volumes into actual collected volume.

To enter the fraction size press the numbered keys until the desired value is displayed, then press the **D** key.

If the desired fraction size is already displayed, press the **D** key.

5.37

Enter the amount to collect in each tube between peaks. If the peak detector is not used, then the value entered here will not be used.

If you are sizing fractions by drops, enter the number of drops. If you are sizing fractions by time, enter the length of time to collect. If you are sizing fractions by volumes, enter the number of pumped volumes to collect. See Section 6.10 or your pump's manual for instructions to convert pumped volumes into actual collected volume.

To enter the fraction size press the numbered keys until the desired value is displayed, then press the **D** key.

If the desired fraction size is already displayed, simply press the **D** key.

5.38

The Fraction Collector can be programmed to stop unconditionally at the end of the programmed time windows or to continue collecting until the red stop rack is reached. The Fraction Collector will always stop at the red stop rack regardless of the length of the time windows program.

Press the **A** key to have the Fraction Collector stop at the end of your time windows program. All material from the column after this time will be sent to waste.

Press the **B** key to continue collecting after the end of your time windows program. The Fraction Collector will collect ALL of the eluant after the end of the time windows until the last position of the red stop rack is reached.

5.39

Enter the time required for the chromatographic eluant to pass from the UV Monitor (or other detector) to the 3-Way Diverter Valve (or the drop former if no valve is being used).

The delay time synchronizes the fluid flow through the peak separator valve or drop former to the UV absorbance chromatograph. This delay may be significant in critical applications or in situations where the UV Monitor is located far from the Fraction Collector. Normally the 3-Way Diverter Valve should be placed as close as possible to the drop former to minimize the volume between those two elements.

To calculate the flow delay time you must know the approximate flow rate and the inner diameter and length of the tubing connecting the UV Monitor to the 3-Way Diverter Valve or drop former. Once you have this information use the formula:

$$5.07 d^2 l / f$$

where d is the ID of the tubing (inches), l is the length of the tubing (cm), and f is the flow rate (ml/min). The time derived from this formula will be in minutes.

If you have the tubing ID in millimeters use the constant 0.007854 in lieu of the 5.07 used with inches.

5.40

This is the third section of the peak separator program menu. Press the **A** key to return to the previous page of the menu.

Press the **B** key to control the program preview. Normally, the Fraction Collector will briefly display the program prior to starting a run. Press the **B** key to either preview the program now or to prevent the automatic preview.

Press the **C** key to change the setup of the Fraction Collector. This includes selecting minutes and seconds vs. minutes and tenths for time and the valve timing.

Press the **D** key to be ready to start the run.

5.41

There are two common conventions for dealing with time in chromatography. The Spectra/Chrom CF-2 Fraction Collector is capable of working with either. If you prefer to deal with time in terms of minutes and tenths of minutes press the **A** key; if you prefer to deal with time in terms of minutes and seconds press the **B** key.

5.42

When sizing fractions by time or volumes, the Fraction Collector automatically delays the start of its movement when a valve is present. This gives the valve time to operate so that no liquid drops between tubes.

The valves sold by Spectrum (Reorder Nos. 124848 and 124849) operate in less than 50 ms. Press the **1** key and then the **D** key to set the time to 50 ms.

5.43

The Fraction Collector can be set to provide you with a preview of your program immediately prior to running it. This provides you with an opportunity to catch any major flaws. Occasionally, however, this delay will not be acceptable.

To disable the automatic preview, press the **B** key. To enable the automatic preview, press the **A** key; this will also cause the program to be previewed now.

To preview the program, but not change the state of the automatic preview, press the **D** key. This will display the program now, but not change the state of the automatic preview.

5.45

You are displaying the various input signals to the Fraction Collector. The only exit from this display is by turning off the Fraction Collector by pressing the  key.

5.49

You have interrupted the program preview by pressing the **STOP** key. Press the **START** key to resume the preview. Press the **PROGRAM** key if you wish to change the variable currently displayed.

6 THEORY OF OPERATION

6.1 CIRCUIT DESCRIPTIONS

Refer to the block diagram, Figure 6-1, and the schematic diagram, Figure 6-2 located at the back of this manual, as needed when following the circuit descriptions.

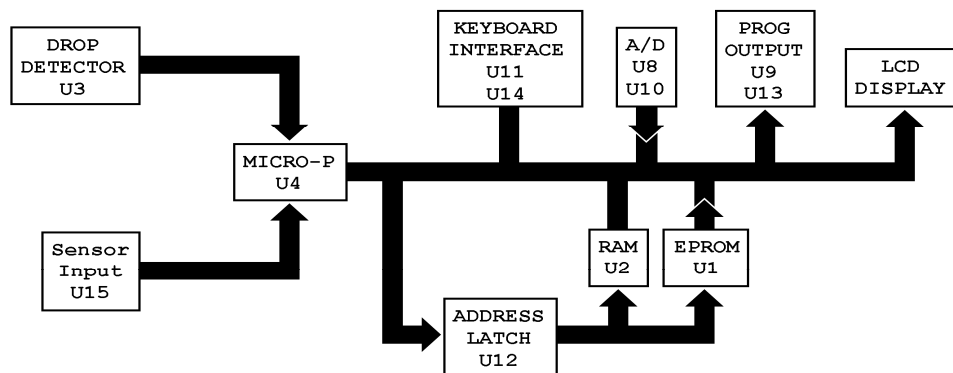

Figure 6-1. CF-2 Fraction Collector Block Diagram.

6.2 POWER SUPPLY

The mains voltage is stepped down to 24 VDC with an external wall-mount transformer. This is fed to three voltage regulators.

The 5V regulator, U6, provides power for all of the logic circuitry. It also has an integral dropout detection circuit which is used to reset the microprocessor when power is applied and to protect the contents of the RAM memory when power is removed.

The 12V regulator, U5, provides power for an external valve, the LEDs in the rack sensor assembly, the LEDs in the drop counter, and for any external equipment connected to the monitor jack. This regulator provides its full 12V output when the Fraction Collector is turned on, but only about 1.25V when the Fraction Collector is connected to the mains but set to standby.

A third 5V regulator, U17, powers the LCD backlight. This same switching regulator is used to supply the negative voltage source required by the analog circuitry in the peak detector. Less than 5 mA is needed so the parasitic charge pump is more than adequate.

6.3 MICROPROCESSOR AND MEMORY

The CF-2 Fraction Collector uses a CMOS version of the venerable 8031 microprocessor operating at 11.0592 MHz. An external latch (U12) is used to construct the 16 bit address bus.

The program for the CF-2 Fraction is stored in a 32K x 8 memory IC. This IC is socketed to allow for user replacement in the event an upgrade becomes available.

An 8K x 8 RAM IC is used to store user programs and runtime variables. A NiCd battery is used to power the RAM while the Fraction Collector is disconnected from the mains. This battery is continually charged while mains power is present.

6.4 LIQUID CRYSTAL DISPLAY

The CF-2 Fraction Collector uses a 2 line, 40 character per line, supertwist liquid crystal display module. The module contains the drivers needed for the liquid crystal elements. The module interfaces directly with the microprocessor's data bus and is controlled by the microprocessor.

6.5 ANALOG INTERFACE

The analog input is used for the peak detection features of the CF-2 Fraction Collector. The detector signal is amplified and conditioned by U10. The full-scale input range is set by placing a jumper at J6 (for a 1V input), J9 (for a 100mV input), or J10 (for a 10mV input). One and only one of these positions should be jumpered. The output of U10 is 2 volts when the input is at its full-scale value.

Analog-to-digital conversion is performed by U8, a dual slope integrating A/D converter. Five conversions are performed each second. This 200 ms interval is the time base for the slope detector.

6.6 KEYBOARD INTERFACE

Integrated circuits U11 and U14 provide the interface between the microprocessor and the keyboard. The CF- 1 Fraction Collector has 22 keys arranged in a 4 by 6 matrix. Twenty times a second the microprocessor scans the keyboard by reading U11 while cycling through the address lines buffered by U14.

6.7 DROP DETECTOR

The drop detector consists of two light emitting diodes (D101 and D102) and a phototransistor (Q101). These are arranged so that falling drops partially block the light path between the diodes and the phototransistor.

The phototransistor serves as a load to the constant current source formed by Q2 and its associated components. When the light falling on Q101 is reduced, its impedance increases and the voltage at pin 1 of the count input jack falls. This is coupled to the input of U3 to cause a well-defined input pulse to reach the processor input.

6.8 POSITION SENSOR

Two reflective sensors (U101 and U102) are used to sense the position of the racks used on the CF-2 Fraction Collector. These are mounted in the rack sensor assembly and sense the presence of the coded holes in the racks used on the Fraction Collector.

The first of these (U101) drives U15A. It senses when a rack is in position under the drop former. This is used to determine when to stop the motor following a tube advance.

The second of the reflective sensors (U102) is used to detect the last position in the special red stop racks. This is used to determine when collection for a run is complete.

6.9 OUTPUT CONTROL

The various state outputs for the Fraction Collector are generated by the microprocessor. The rack event, tube event, valve, pump stop, end of run, and motor control outputs are generated by the microprocessor and latched by U13. A high current driver (U9) is used to buffer the latched outputs.

6.10 VOLUME CONVERSION

The Spectra/Chrom CF-2 Fraction Collector is capable of sizing fractions based on pumped volumes when it is used with a Spectra/Chrom MP-1, or MP-2 Pump. The relationship between the volume numbers and the actual volume depends upon both the pump used and the size of tubing used with the pump.

The actual pumped volume is dependent upon the size tubing used; the numbers given here are only approximate. If additional accuracy is desired, place a new piece of tubing in the pump and run it for 30 minutes at approximately the desired speed to break in the tubing. Then measure the flow and adjust the volume number accordingly.

The Spectra/Chrom MP-1 and MP-2 Pumps are designed to be used with a variety of tubing sizes. Table 6-1 shows the relationship between volume counts and actual volumes for these pumps.

Table 6-1. Volume Conversion

Tubing Size:	13	14	16	15	17	18
MP-1 volume counts per ml	83.0	24.0	6.30	3.00	1.80	1.32
MP-1 ml per volume count	0.012	0.042	0.16	0.33	0.56	0.76
MP-2 volume counts per ml	5.20	1.50	0.39	0.19	0.112	0.083
MP-2 ml per volume count	0.19	0.67	2.50	5.30	8.90	12.1

Table 6-2 Remote Connector Pin Assignments

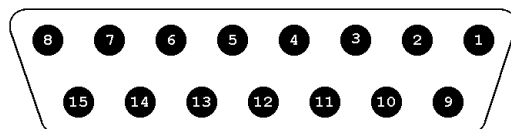

Figure 6-3. Remote Connector on Rear Panel.

Pin #	Function	Direction	Description
1	+12V	—	12V DC at 100 mA maximum. Only available when the fraction collector is operating.
2	Advance	Input	Open collector or contact closure to common will cause the fraction collector to advance 1 tube position except at the end of a run.
4	Rack Event	Output	Open collector output referenced to common. One pulse for every rack change.
5	Tube Event	Output	Open collector output referenced to common. One pulse for every tube advance.
7	Start	Input	Open collector or contact closure to common will act the same as the START key.*
8	Earth	—	Connection to fraction collector case and mains Earth.
9	Common	—	Signal common.
10	Signal	Input	Analog input for peak separator function.
11	Motor Stop	Input	Open collector or contact closure to common will prevent the motor from running.
12	Valve	Output	Open collector output for switching valve.
13	Pause	Input	Open collector or contact closure to common will prevent the fraction collector from accumulating volume, time, or drops.
14	End of Run	Output	Open collector output referenced to common. Provides a signal when collection is complete

Table 6-3 Pump or Drop Count Connector Pin Assignments



Figure 6-4. Pump or Drop Count Connector on Rear Panel.

Pin #	Function	Direction	Description
1	count	input	Drop counter input.
2	+12V supply	—	Filtered +12V supply for drop counter photocell.
3	+12V supply	—	Resistive supply for external count switch.
4	common	—	Signal common.
5	pump stop	output	Open collector output referenced to common. Active to stop a pump between tubes and at the end of the run.
6	30mA source	—	Current source for drop counter light source.

Table 6-4 Pump Stop Connector Pin Assignments

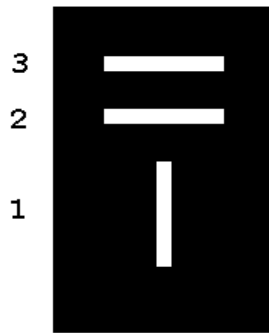

Figure 6-5. Pump Stop Connector on Rear Panel.

Pin #	Function	Direction	Description
1	N.O.	—	Normally open relay contact. Closed at end of run or when stopped.
2	N.C.	—	Normally closed relay contact. Open at end of run or when stopped.
3	Armature	—	Relay armature contact. Common to N.O. and N.C pins.

Table 6-5 Valve Connector Pin Assignments

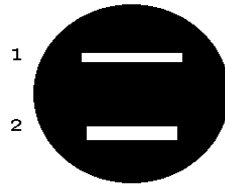

Figure 6-6. Valve Connector on Rear Panel.

Pin #	Function	Direction	Description
1	Valve	Output	Open collector output referenced to common. Active to open 2-Way security valve or to switch 3-Way valve to collect.
2	+12V DC	—	

7 MAINTENANCE

7.1 INTRODUCTION

This section describes the maintenance procedures for the CF-2 Fraction Collector. These procedures can be performed by any person with proficiency in instrument maintenance or by an electronic technician. They do not require the use of specialized equipment. Additional information can be obtained from the Spectrum Technical Service Department at (800) 459-9700.

7.2 CASE TOP REMOVAL

To remove the case top and gain access to the interior of the instrument:

1. Unplug the instrument from the power outlet and disconnect all other wiring from the instrument.
2. Detach the rack sensor from the case top by removing its thumbscrew and sliding the sensor back out of its mounting block.
3. Unlatch the draw catches by pulling outward at their upper edge, then pushing them down-and-out. Lift the case top straight up from the base.
4. If necessary, remove the drip shield by lifting the back of the pan first and then pulling it straight up until clear.

7.3 CLEANING SENSOR WINDOW

If the window for the rack sensor becomes dirty, the Fraction Collector may skip tubes or stop only intermittently. If the window becomes dirty it may be cleaned with the following procedure:

1. Remove the rack sensor drip shield by gently pulling one end of the drip shield over the "ears" on the sensor body. Do not deform the drip shield.
2. Use a clean cotton swab dampened with isopropyl alcohol and gently clean the sensor. Hardened deposits may need repeated swabbing. Do not immerse the sensor assembly.
3. Gently dry the window with another clean cotton swab.
4. Replace the rack sensor drip shield by placing one end on the appropriate ear of the sensor body and gently prying the opposite end over its ear.

7.4 SENSOR ASSEMBLY REPLACEMENT

If cleaning the sensor window does not correct a sensor problem, the entire assembly will need to be replaced. To replace the sensor assembly:

1. Remove the case top and internal drip shield as described in Section 7.2.
2. Disconnect the sensor plug (Figure 7-4) from the circuit board.
3. Cut the wire tie which secures the sensor's cable and pull the cable out the back of the cabinet. Discard the old sensor assembly.
4. Feed the cable from the new sensor assembly into the cabinet and connect the plug to the circuit board. Use a wire tie to secure the sensor cable to the cabinet.
5. Calibrate the new sensor as described in Section 7.7
6. Replace the internal drip shield and the case top.

7.5 SHUTTLE CLEANING

If the black shuttles become jammed, it is probably due to their becoming clogged with foreign material.

If the shuttles become jammed, you should remove the case top, as described in Section 7.2, and wash it in warm water and detergent while agitating the shuttles. Then rinse it with warm water. This will probably clear the jam.

If washing the case top does not rectify the problem, the shuttles will need to be removed to clean them individually and replace any which may have broken.

To remove the shuttles:

1. If possible, advance the test tube racks so that the third test tube of any rack is in position to be filled.
2. Remove the case top from the Fraction Collector, as described in Section 7.2, and place it on a flat work surface.
3. Remove all of the test tube racks.
4. Remove the 4 screws from the top of the center island cover and remove the cover.
5. Remove the necessary shuttles.

NOTE: If you were unable to get the third test tube under the fill position in step 1 or you have disturbed the position of the two end shuttles in the narrow passages at the ends of the center island you will need to perform the shuttle timing procedure described in Section 7.6 below.

6. If you have not disturbed the end shuttles, replace the shuttles and reassemble the Fraction Collector. Be sure that all 29 shuttles are present and that the small diameter posts are all oriented the same direction.

7.6 SHUTTLE TIMING PROCEDURE

If one or more shuttles becomes broken it may be necessary to reset the shuttle timing. Follow the procedure in Section 7.5 to remove all of the shuttles. Be sure the shuttles and the shuttle support pan are clean before beginning this procedure.

1. Orient the case top so that the end of the island with the timing mark cut into it is closest to you, as shown in Figure 7-1.

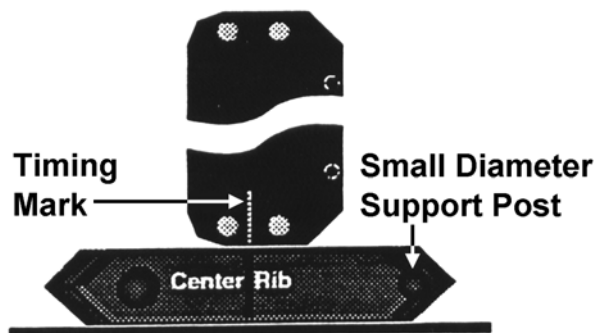

Figure 7-1. Initial Shuttle Position for Shuttle Timing Procedure

2. Place one shuttle to the left of the center island with its small diameter post to the right. Push the shuttle into the near tunnel until the center rib aligns with the timing mark

3. Place a second shuttle to the right of the center island, with its small post also to the right. Then push this shuttle into the far tunnel, large post end first, until the edge aligns with the exit angle on the center island as shown in Figure 7-2.

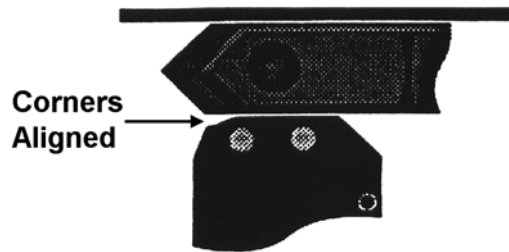

Figure 7-2. Far Tunnel Final Position for Shuttle Timing Procedure

4. Check to make sure the shuttle in the near tunnel is in its correct final position. This is shown in Figure 7-3. The two edges need only align to within 1/16".

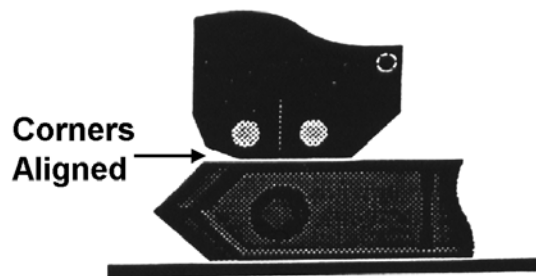

Figure 7-3. Near Tunnel Final Position for Shuttle Timing Procedure

5. If both shuttles are not aligned, repeat this procedure.
6. Without disturbing the two end shuttles, place the remaining 27 shuttles around the island, 14 to the left and 13 to the right. All of the shuttles should be oriented with their small post to the right and the large post to the left.
7. Replace the center island cover and then put the case top back on the Fraction Collector.

7.7 CALIBRATING THE RACK SENSOR

If the fraction collector is skipping tubes, especially the final tube in each rack you may need to recalibrate the rack sensor. If you replace your rack sensor you will need to calibrate the rack sensor.

To calibrate the rack sensor:

1. Remove the case top and internal drip shield as described in Section 7.2.
2. Place the case top on the same surface as the fraction collector case bottom and place the rack sensor in position on the case top. You will probably have to place the case top to the rear of the case bottom.
3. Use an electronic voltmeter to measure the sensor response, connect the red (+) lead to the cycle test-point on the circuit board (Figure 7-4) and the black (—) lead to the common test-point.
4. Connect mains power to the fraction collector and turn it on. Do not drop any stray items into the fraction collector while power is applied.

7.8 SETTING THE FULL-SCALE VOLTAGE

The CF-2 fraction collector can operate with detectors having a 1V, 100 mV, or 10 mV full-scale output voltage. When the fraction collector is shipped by the factory it is set to expect a 1 V full-scale detector. This is because Spectrum's detectors all have a 1 volt full-scale output. The following procedure may be used to change this to either the 100 mV or 10 mV range.

1. Remove the case top and drip shield from the fraction collector as described in section 7.2.
2. Locate J6, J9, and J10 in figures 7-4 and 7-5. There should be a small jumper bridging one of these sets of pins. Remove this jumper but do not discard it.
3. To set the fraction collector for a 1V full-scale input range use the jumper from step 2 to bridge the pins at J6. For a 100 mV full-scale input range use the jumper to bridge the pins at J9. For a 10 mV full-scale input range use the jumper to bridge the pins at J10.
4. Replace the drip shield and the case top.

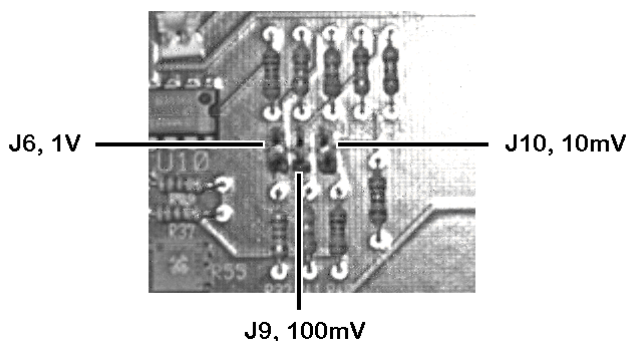

Figure 7-5. Voltage Jumpers Detail

7.9 REPLACING THE EPROM

Prolonged exposure to X- or Gamma-rays may erase the EPROM in which the CF-2 program is stored. If this occurs, the EPROM will need to be replaced. Additionally, if a software upgrade becomes available it will be necessary to replace the EPROM to have access to the enhancements.

To replace the EPROM:

1. Remove the case top and internal drip shield from the Fraction Collector, as described in Section 7.2.
2. Locate U1 in Figure 7.4. Make note of its orientation and use a small screwdriver to alternately pry each end of the IC from its socket until it is free.
3. Take the new EPROM and unwrap it. Carefully remove it from its foam pad.
4. While holding the pins of the EPROM in one hand, touch the case of the Fraction Collector. This will relieve any static charge.
5. Place the new EPROM into the socket on the circuit board. Make sure all of the pins enter the socket, and that the new EPROM has the same orientation as the old one.
6. Replace the drip shield and the case top.

7.10 VOLTAGE AND FREQUENCY CHANGES

The time base used by the CF-2 Fraction Collector is derived from an internal crystal oscillator. The Fraction Collector will operate from line frequencies of 45 to 65 Hz without any internal modifications.

A variety of external transformers can be used with the CF-2 Fraction Collector. Each of these is designed to have an output voltage of 14 VAC. Use the external transformer whose input specification most nearly matches the mains power available. Please call Spectrum's Technical Service Department at (800) 459-9700, +1-281-443-2900 or service@lplc.com for assistance in selecting a replacement transformer.

7.11 SELF-TEST

When the Fraction Collector is turned on it automatically tests its internal functioning for gross errors. An additional, more comprehensive test mode is also included. To activate the test mode press and

hold down the **A** , **1** , and  keys on the Fraction Collector immediately after turning it on.

7.12 SERVICE DEPARTMENT

If you have trouble with the Fraction Collector or need parts information contact Spectrum's Technical Service Department at (800) 459-9700, +1-281-443-2900, fax (281) 443-3100, or email service@lplc.com. If you write, please address your inquiry to:

Spectrum Chromatography
Service Department
PO Box 672026
Houston, TX 77267-2026 USA

Please contact the Service Department prior to returning a Fraction Collector for repair. Many problems are solved with a simple telephone or mail consultation.

7.13 SHIPPING RETURNS

Be sure that all parts and hardware are back in place before packing a return. When shipping the fraction collector, the mast must not be attached to the case top. Wrap the return in heavy paper or a plastic bag. Put the unit in a strong cardboard box with at least three inches of resilient packing material (shredded paper, foam, etc.) on each side of the return. Seal the package with reinforced tape. Send the return to the address given by the Technical Service Department during your consultation.



It is important that the return be well packed and shipped insured. Claims for damage during shipping must be settled between you and the carrier prior to repair.

7.14 REPLACEMENT PARTS

When ordering replacement parts, please first consult with a Technical Service Representative to determine exactly which items need to be replaced. The following information will be beneficial in determining the necessary part:

- Part No. of the unit
- Serial number of the unit
- Approximate date of purchase of the unit

TABLE 7-1. TECHNICAL TROUBLESHOOTING CHART

KEYBOARD	DISPLAY	MOTOR	CHECK:
No response	Blank	No movement	<ul style="list-style-type: none"> a. AC adapter plugged in? b. Press  key. c. Fuse F1. d. Regulator U11.
No response	Top line black, bottom line blank	No movement	<ul style="list-style-type: none"> a. EPROM U4. b. Regulator U11. c. Processor U2.
No response	Top line black bottom line blank	Runs continuously	<ul style="list-style-type: none"> a. EPROM U4. b. Processor U2.
Responds	Normal display	Runs continuously	<ul style="list-style-type: none"> a. Make sure that at least one tube rack is in place. b. Sensor assembly in place? (Make sure that the thumbscrew holding the sensor is tight.) c. Press the  key. d. Clean sensor assembly. e. Driver Q2. f. Replace sensor assembly.
Responds	Normal display	No movement	<ul style="list-style-type: none"> a. At red rack? b. External Pause input? c. Driver Q2.
Responds	Blank	Behaves Normally	<ul style="list-style-type: none"> a. LCD connection to circuit board.

8 PROGRAMMING EXAMPLES

8.1 INTRODUCTION

Since the operation of a programmable instrument can be daunting, some programming examples are provided here. These examples show how the program relates to the chromatography and not which keystrokes are used to enter the program. Section 4 provides information on how to enter programs.

8.2 EXAMPLE 1

In this example, the researcher had a mixture of hemoglobin, ribonuclease and Cytochrome C to be separated on a hydroxylapatite column. Using a phosphate gradient at a pH of 9, all three peaks have a width of about 15 minutes. The hemoglobin peak is centered at about 25 minutes, the ribonuclease peak at about 38 minutes and the Cytochrome C peak at 55 minutes.

Since the researcher was only interested in purifying the ribonuclease, two time windows were used in the program. The first was from 0:00 to 28:00 with a status of SKIP. This allowed most of the hemoglobin to be sent to waste without dirtying any labware. Some of the hemoglobin was collected, however, as not to miss any of the ribonuclease.

The second time window was from 28:00 to 48:00 with a status of PEAK ONLY. Since the Fraction Collector will advance a tube at the end or beginning of a peak, the ribonuclease was relatively free of hemoglobin, even though some of the early tubes contained chiefly the hemoglobin fraction.

By not having any further time windows, and telling the Fraction Collector to stop after the last time window, the Cytochrome C fraction was avoided.

Since all of the peaks were the same width (15 minutes) the slope detector was set to expect a peak width of 10 minutes with no broadening.

8.3 EXAMPLE 2

In this example a researcher wishes to desalt a large quantity of an unspecified protein mixture using a size-exclusion media. To desalt a one liter sample in one pass, a 15 cm diameter x 30 cm long column will be used. A UV Monitor on the column outlet will monitor protein concentration to ensure only protein fractions are collected.

Since an odd peak shape is expected, the level detector will be set to a threshold of 20% while leaving the slope detector inactive. A single time window will be pro-programmed from 0:00 to 999:5 with a status of PEAK ONLY, since only the peak portion is desired.

This program will enable the Fraction Collector to collect only the desalted protein and send the salt to a waste container for disposal.

8.4 EXAMPLE 3

In this example a researcher wishes to overlay the results of several injections in the same set of test tubes. A diverter valve (part 124849), a remote cable (part 124871) and an autoinjector are needed to perform this task.

The remote cable is used to restart the fraction collector with every new injection. The injection output from the injector should be connected to the start input on the fraction collector (pin 7 on the remote connector).

The fraction collector is then programmed to use the peak separator (section 4.3).

Both the peak and non-peak fraction sizes are set to be the amount to collect in each tube during each run (section 4.7). The total amount collected in each tube will be the set amount multiplied by

the number of runs. The collection is set to end at the red rack and not at the end of the time windows.

The peak detector is set to OFF (section 4.5)

To collect all of the chromatogram, delete all of the time windows (section 4.6). To skip an initial portion of the chromatogram, program a single time window. Set the ending time to the length of time to skip and, of course, set the status to skip. The second window should have an ending time of 0:00 so that there will not be a second window.

Determine about how much time you need to allow for each run and about how much time each tube will be filling. Leave the red rack in position and remove enough of the white racks from right before the red rack so that the number of tubes multiplied by the amount of time per tube is less than the injector repeat time. This way the fraction collector will be able to make a complete circuit of the racks during each run.

Each injection will now start the fraction collector and it will run to completion during each run. This will overlay the fractions of each run on top of the previous ones. Make sure that the tubes can hold enough so that the overlaid fractions do not overflow the tubes.

8.5 EXAMPLE 4

In this example a researcher wishes to collect a single fraction from a series of serial injections. A diverter valve (part 124849), a remote cable (part 124871) and an autoinjector are needed to perform this task.

The remote cable is used to restart the fraction collector with every new injection. The injection output from the injector should be connected to the start input on the fraction collector (pin 7 on the remote connector).

The fraction collector is then programmed to use the peak separator (section 4.3).

Both the peak and non-peak fraction sizes are set to be the amount to collect in each tube during each run (section 4.7). To collect a single tube per run, set the fraction size to be larger than the time you will be collecting. To collect several tubes during a run, set the fraction size to be the amount you wish to collect per tube. The collection is set to end after the last time window and not at the red rack.

The peak detector is set to OFF (section 4.5)

Program 2 time windows (section 4.6). Set the first time window to the length of time to skip at the start of the chromatogram and set the status to skip; this lets you skip an initial part of the chromatogram. Set the second time window to the ending time of the part of the chromatogram you wish collect and set the status to collect. Set the ending time of the third window to 0:00 so that there will be no more windows.

Each injection will now start the fraction collector and it will then set the valve to waste advance to the next tube and wait for the skip time to expire. After the skip time expires, the fraction collector will advance to the next tube, set the valve to collect and begin collecting fractions. After the collect window expires, the fraction collector will set the valve to waste, advance to the next tube, and wait for the next start signal.

Since this will use at least 3 tubes per run, a maximum of 58 runs can be done unattended.

9 ORDERING INFORMATION

Part No.	Description
124844	CF-2 Fraction Collector, 100 V (Japanese plug)
124845	CF-2 Fraction Collector, 115 V (US plug)
124846	CF-2 Fraction Collector, 230 V (Europlug)
124866	CF-2 Fraction Collector, 250 V (Great Britain and Australia)
124839	Replacement fittings, pkg.
124852	Replacement case top
124853	Rack Set, 12 to 13 mm tubes, 6 per rack, 174 tubes maximum
124854	Rack Set, 10 to 16 mm tubes, 4 per rack, 116 tubes maximum
124855	Rack Set, 17 to 18 mm tubes, 4 per rack, 116 tubes maximum
124856	Rack Set, 27 to 28 mm vials, 3 per rack, 42 tubes maximum
124857	Rack stand, holds up to 10 racks
124858	Dust Cover
124848	2-Way Safety Valve
124849	3-Way Diverter Valve
124838	High Flow 3-Way Diverter Valve
124874	Mast Package
124876	4-Column Adapter (requires mast package)
124865	Cable, UV monitor to fraction collector, signal for peak separator
142615	Cable, UV monitor to fraction collector, signal for peak separator and event marks to UV monitor
124815	Cable, pump to fraction collector, pump stop at end of run
124859	Cable, pump to fraction collector, for volumetric collection

Last Revision Date: 07/02/2009



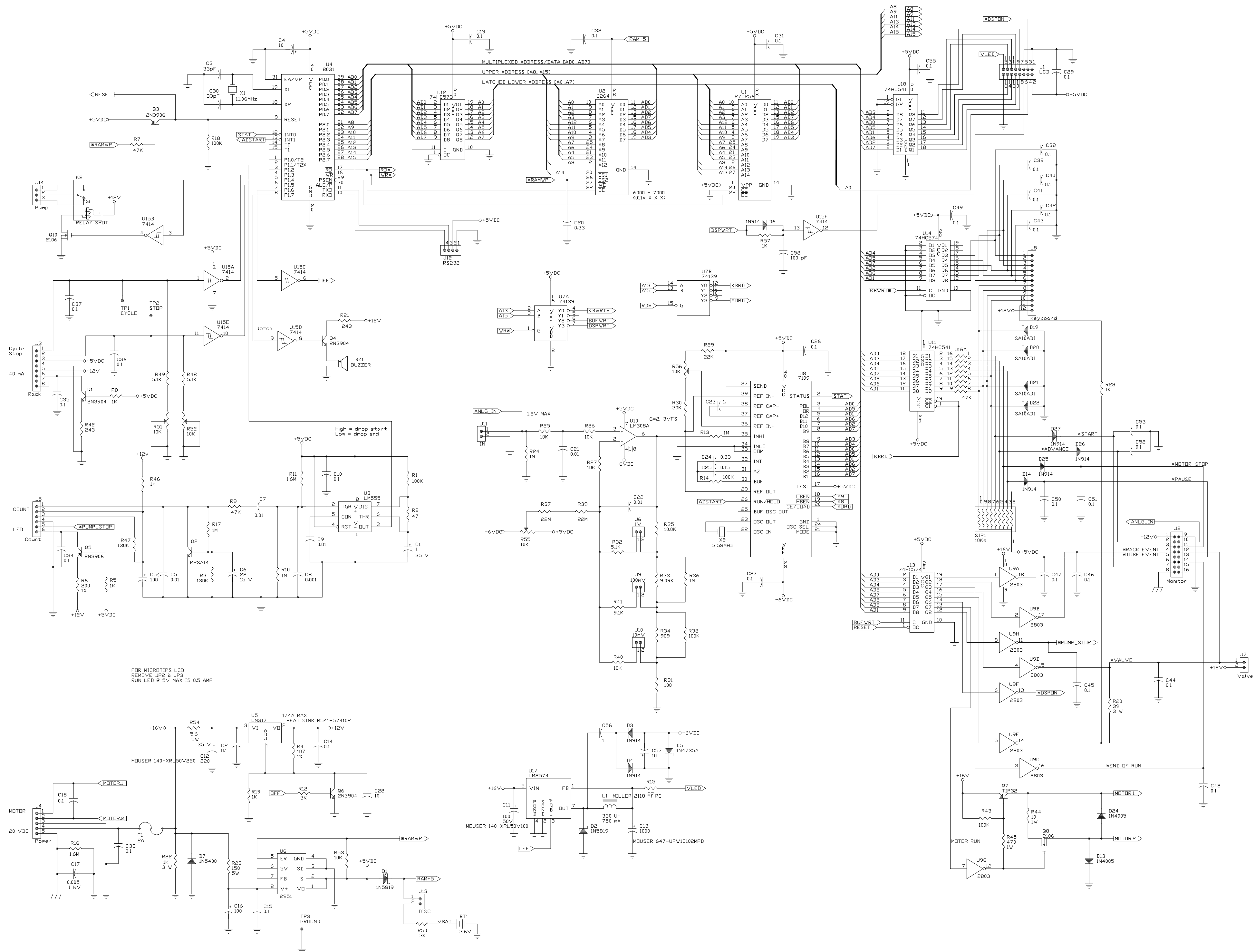

FOR MICROTIPS LCD
 REMOVE JP2 & JP3
 RUN LED @ 5V MAX IS 0.5 AMP

Mouser 140-XRL50V220

Mouser 140-XRL50V100

Mouser 647-UPW1C102MPD